

Travaux de réouverture et de restauration
hydromorphologique de la Verse de Beaugies
sur la commune de Guiscard

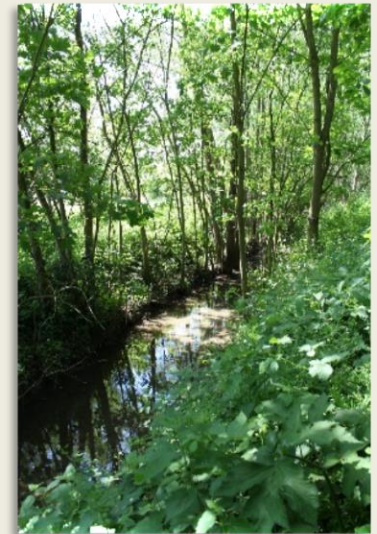

Réunion Publique du 18/01/2018



Sommaire

1 / Rappel des objectifs

2 / Rappel des séquences

3/ Aménagements prévus

4/ Montant estimatif des travaux

5/ Planning prévisionnel



1 - Rappel des objectifs

Réduire le risque d'inondation sur la commune

Rétablir la continuité écologique

Restaurer le fonctionnement hydromorphologique
de la Verse de Beaugies

Ce projet devra tenir compte non seulement de l'ensemble des contraintes liées aux infrastructures existantes et projetées mais aussi des objectifs hydrauliques, écologiques et paysagers.



2 - Rappel des Séquences



Séquences en amont de la commune

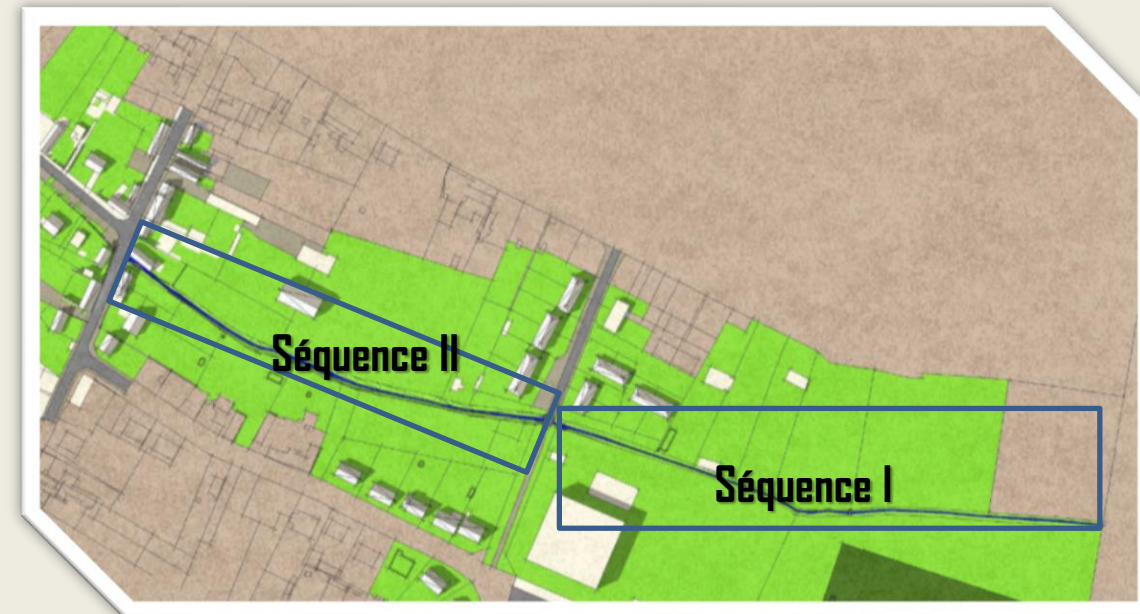



Séquences Urbaines

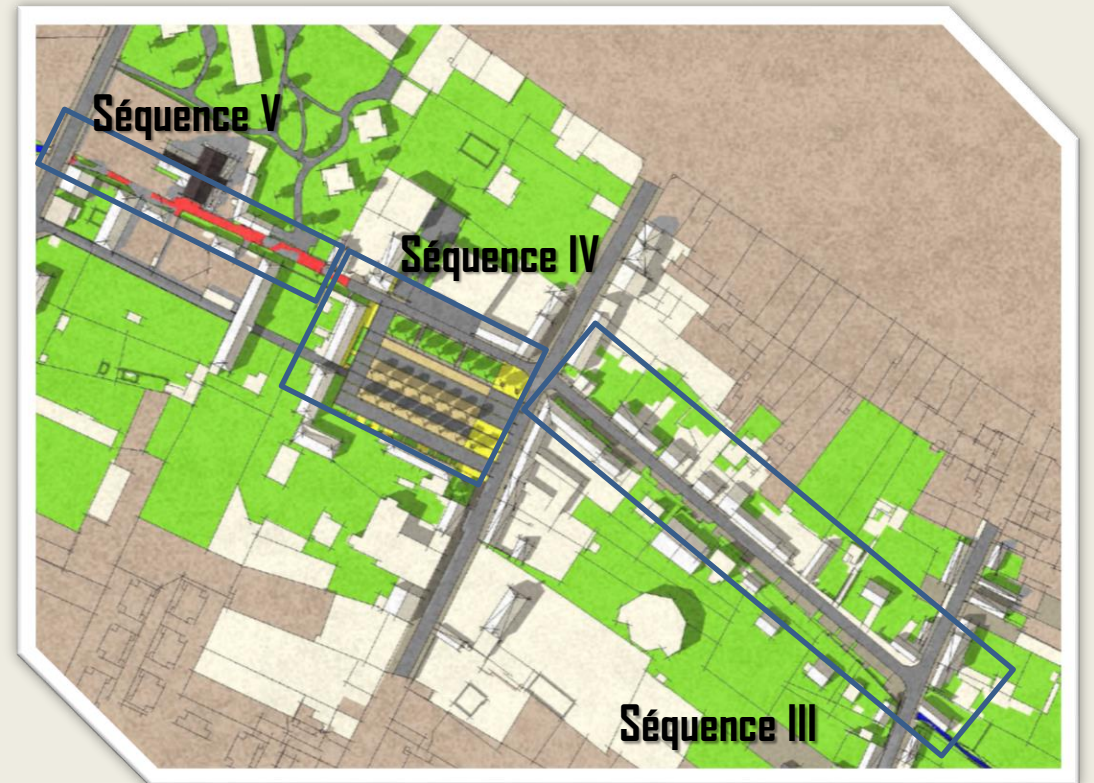
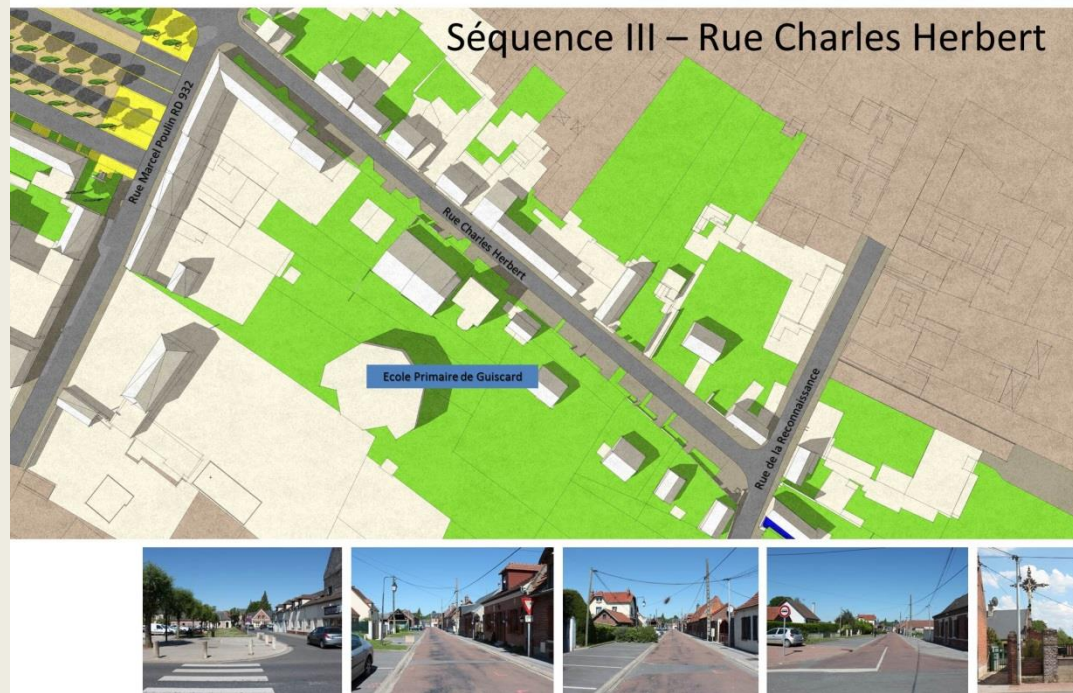



Séquence en aval de la commune





3 – Aménagements Prévus



Aménagements prévus – Emprise totale

S6 : Travaux de restauration
Env. 300 ml

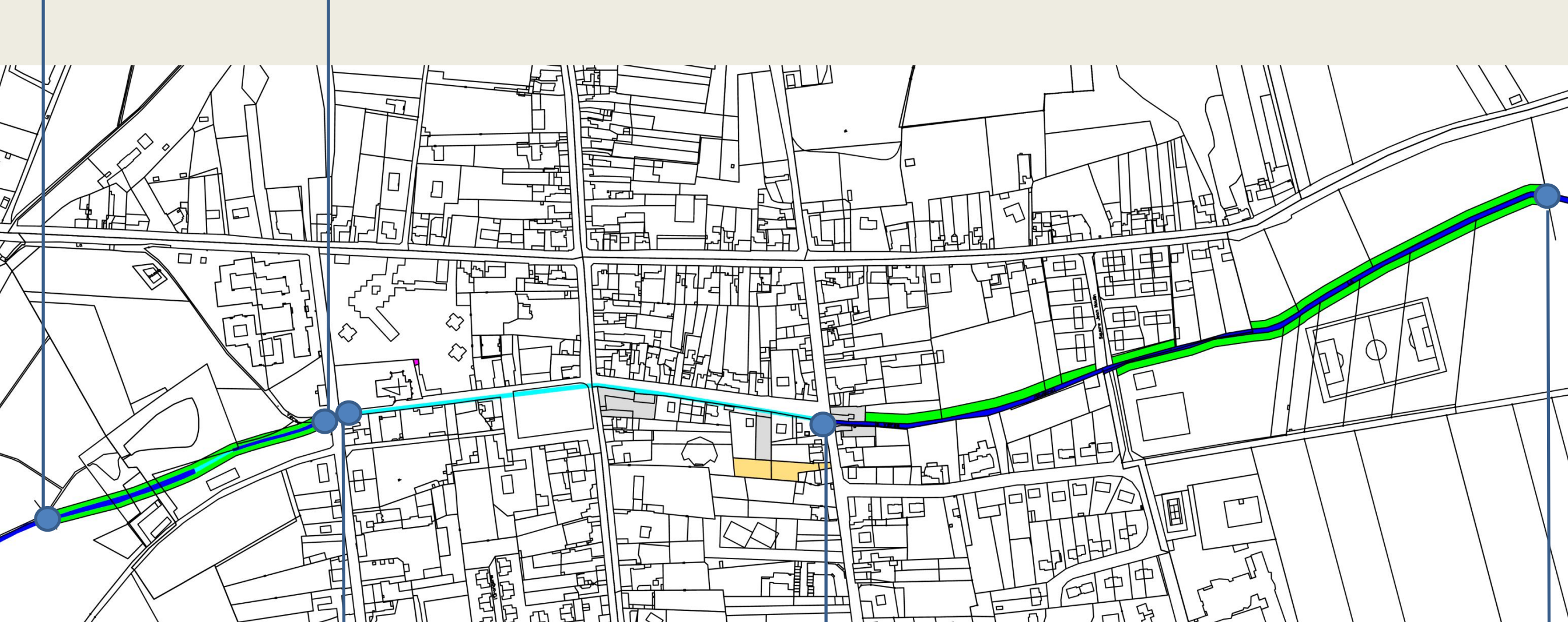

S3, 4 et 5 : Travaux de réouverture
Env. 500 ml

S1 et 2 : Travaux de restauration
Env. 500 ml



Aménagements prévus - Séquence 1

Square J. Moulin

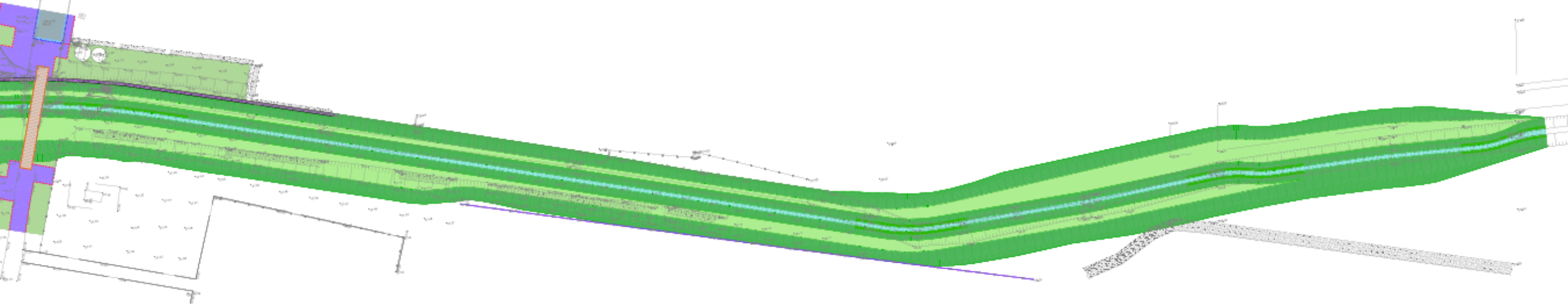

Reprofilage des berges

Avec fascines de branches de saules

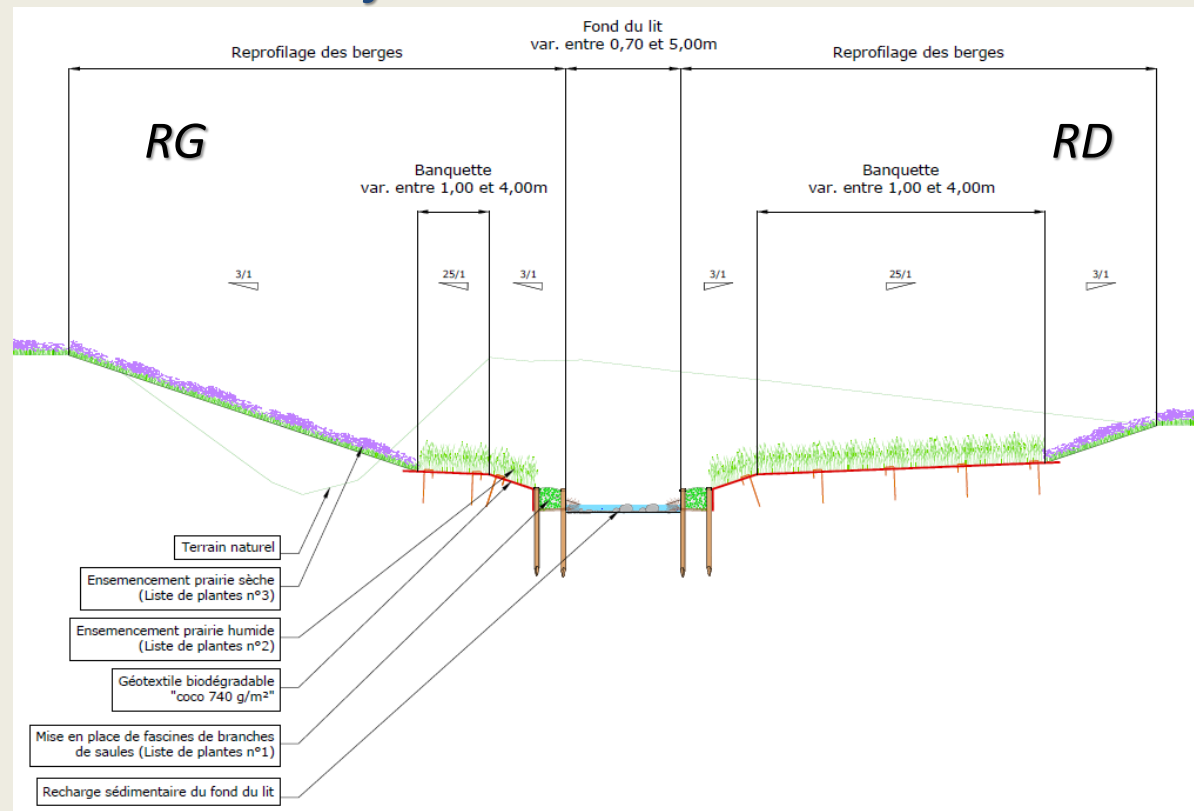

Avec fascines d'hélophytes

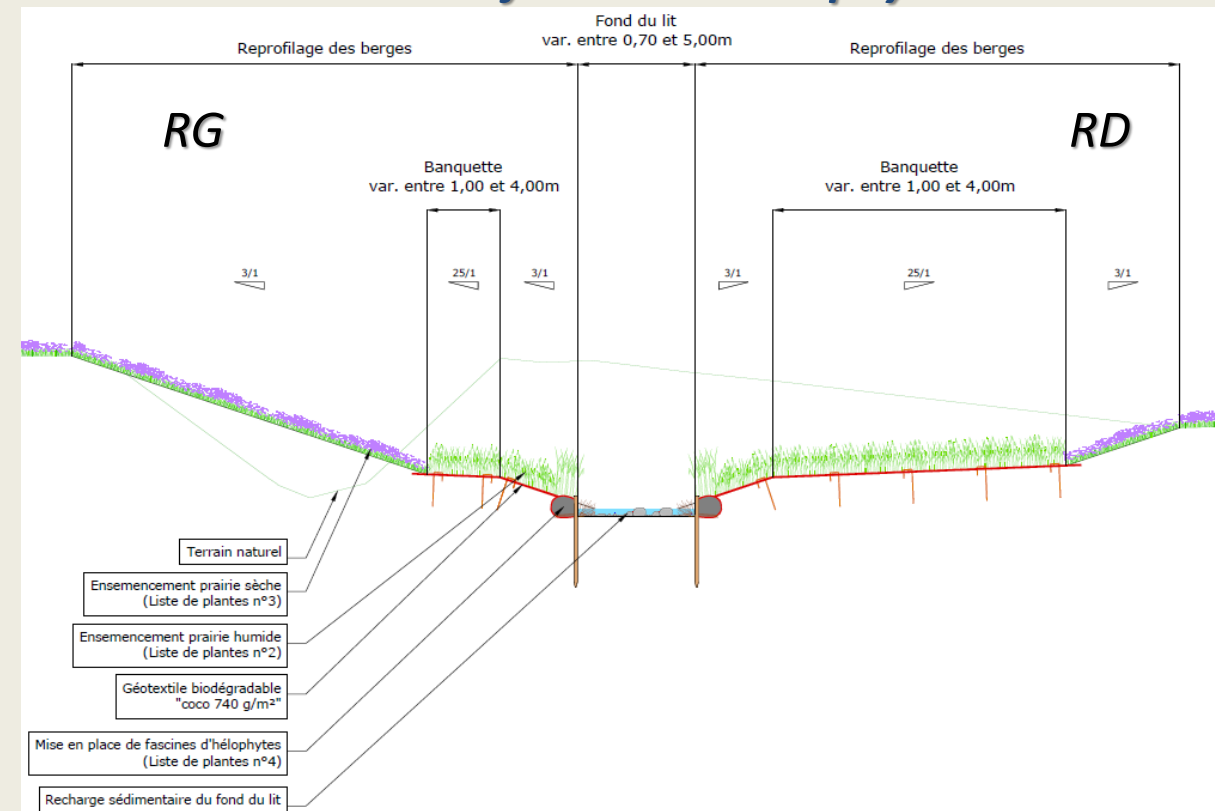



Aménagements prévus - Séquence 2

Square J. Moulin

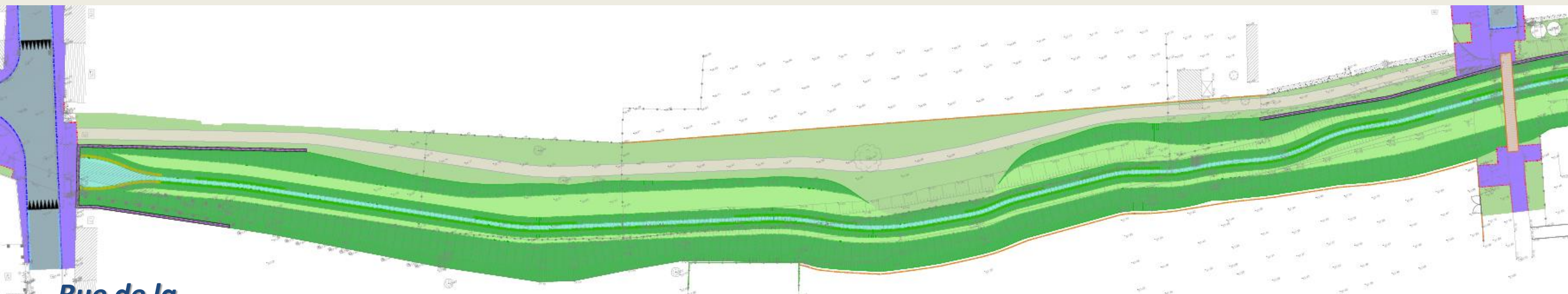

Rue de la
Reconnaissance

Reprofilage des berges

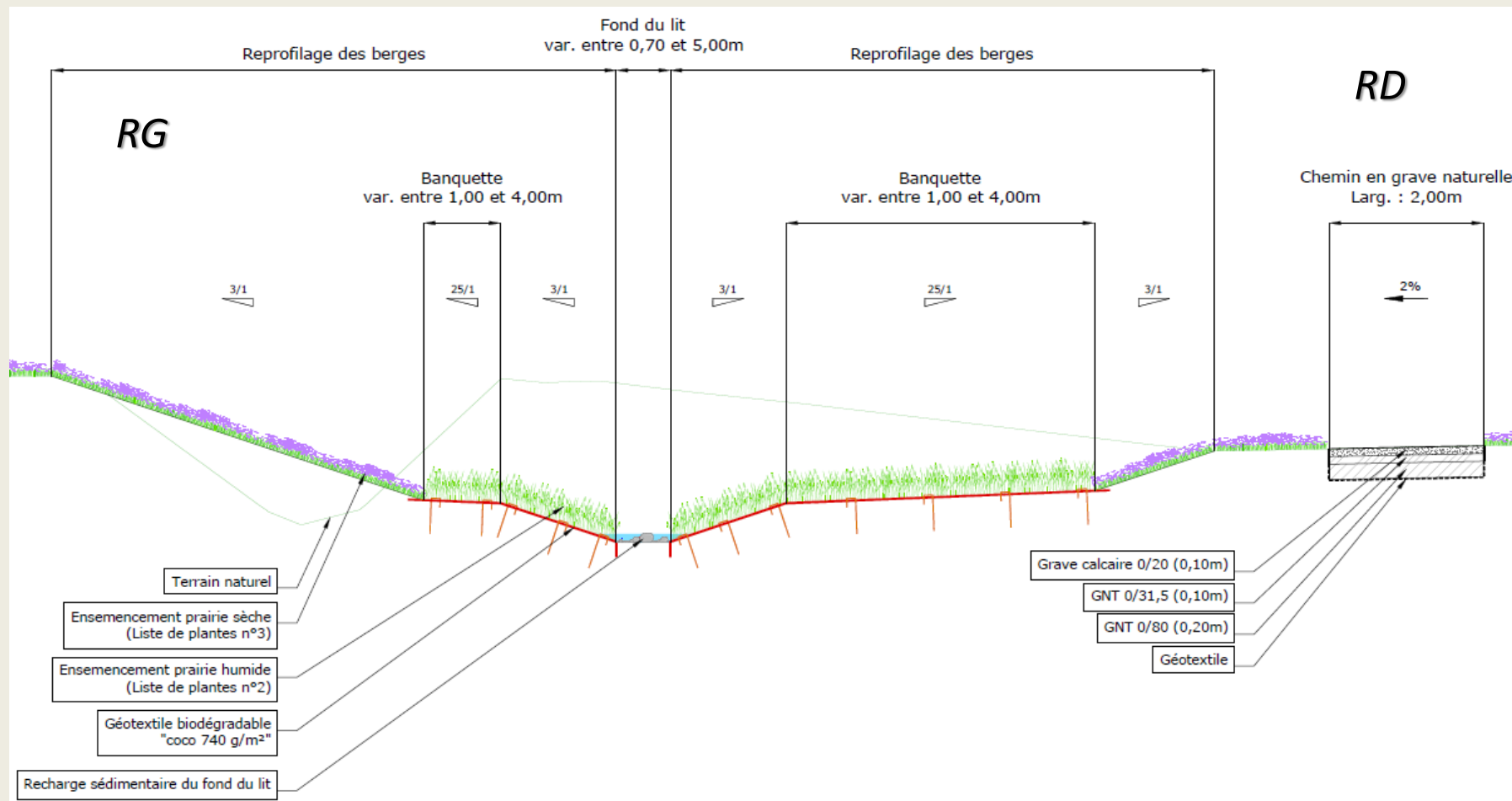



Aménagements prévus - Séquence 2

Square J. Moulin

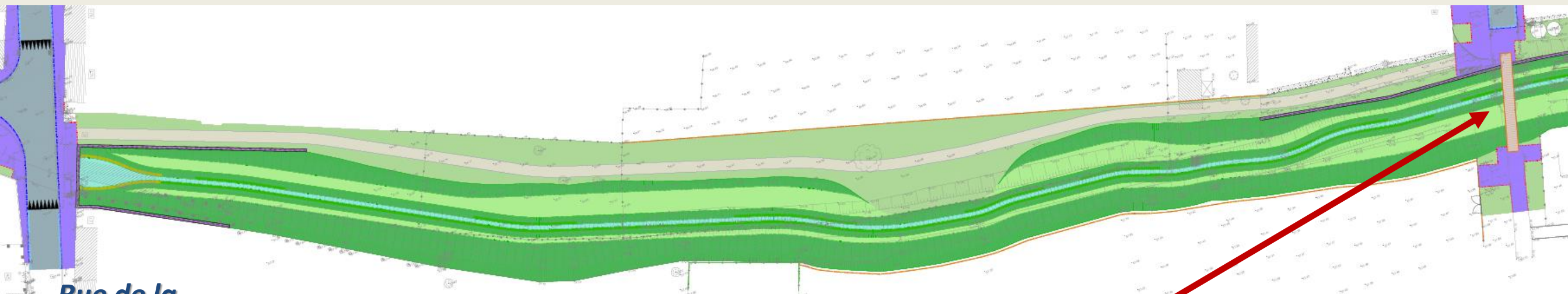

Rue de la
Reconnaissance

Passerelle piétonne au niveau du Square Jean Moulin

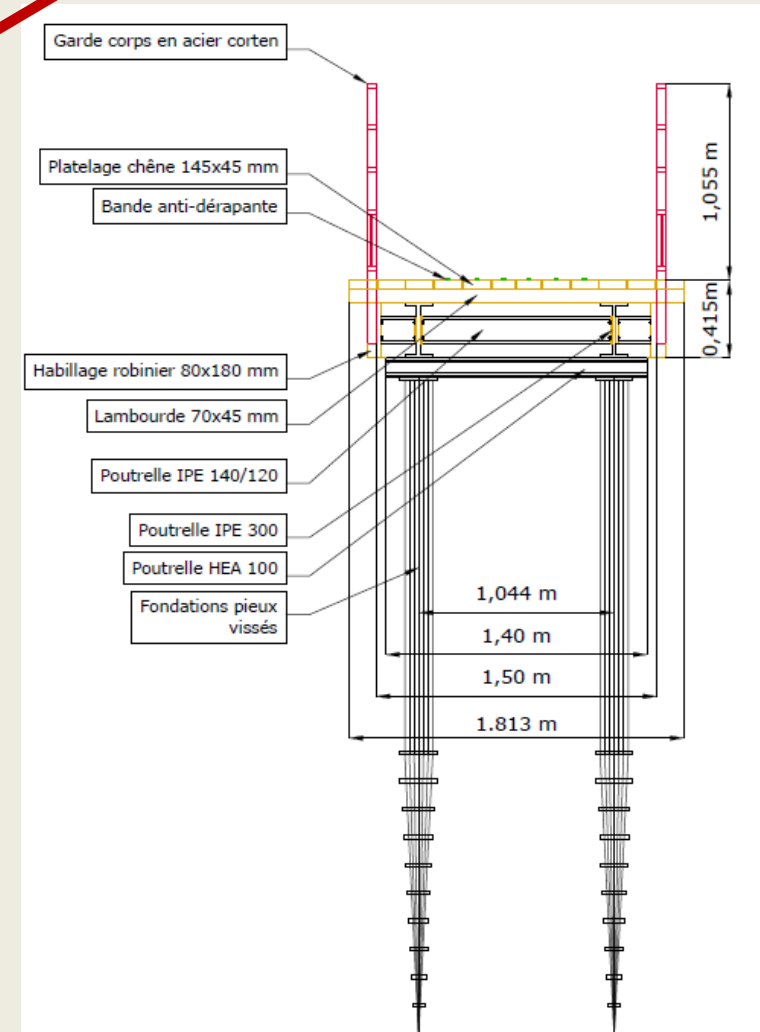
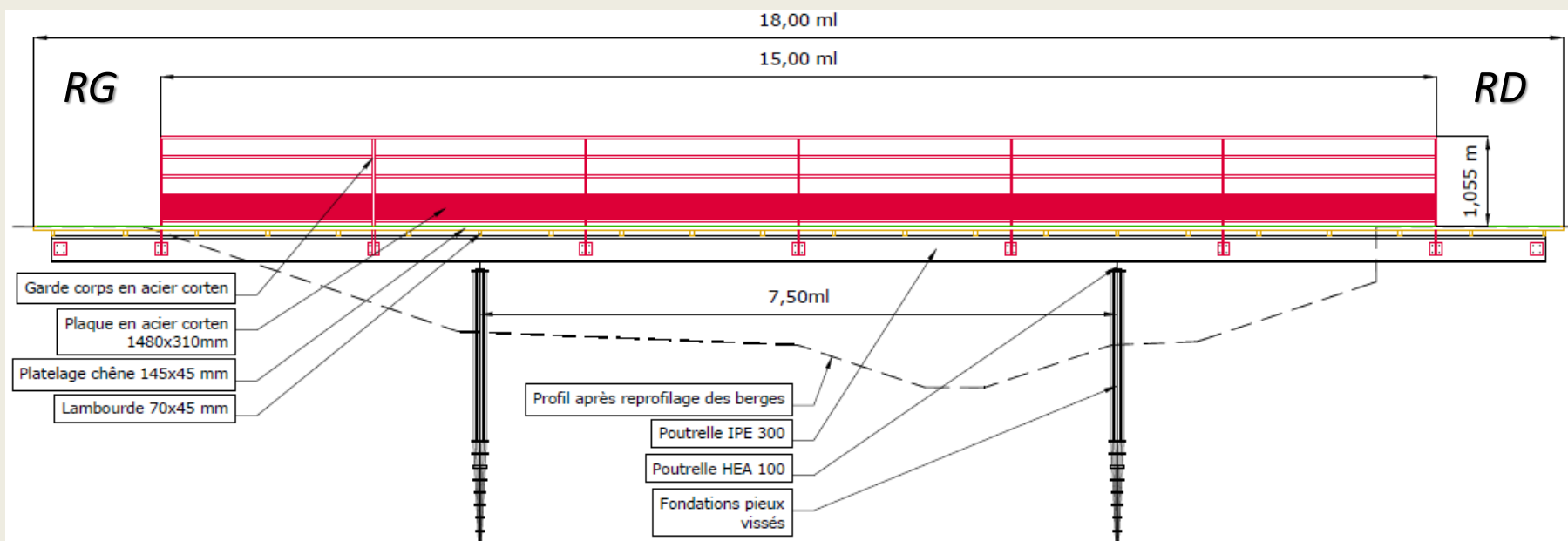



Aménagements prévus - Séquence 3

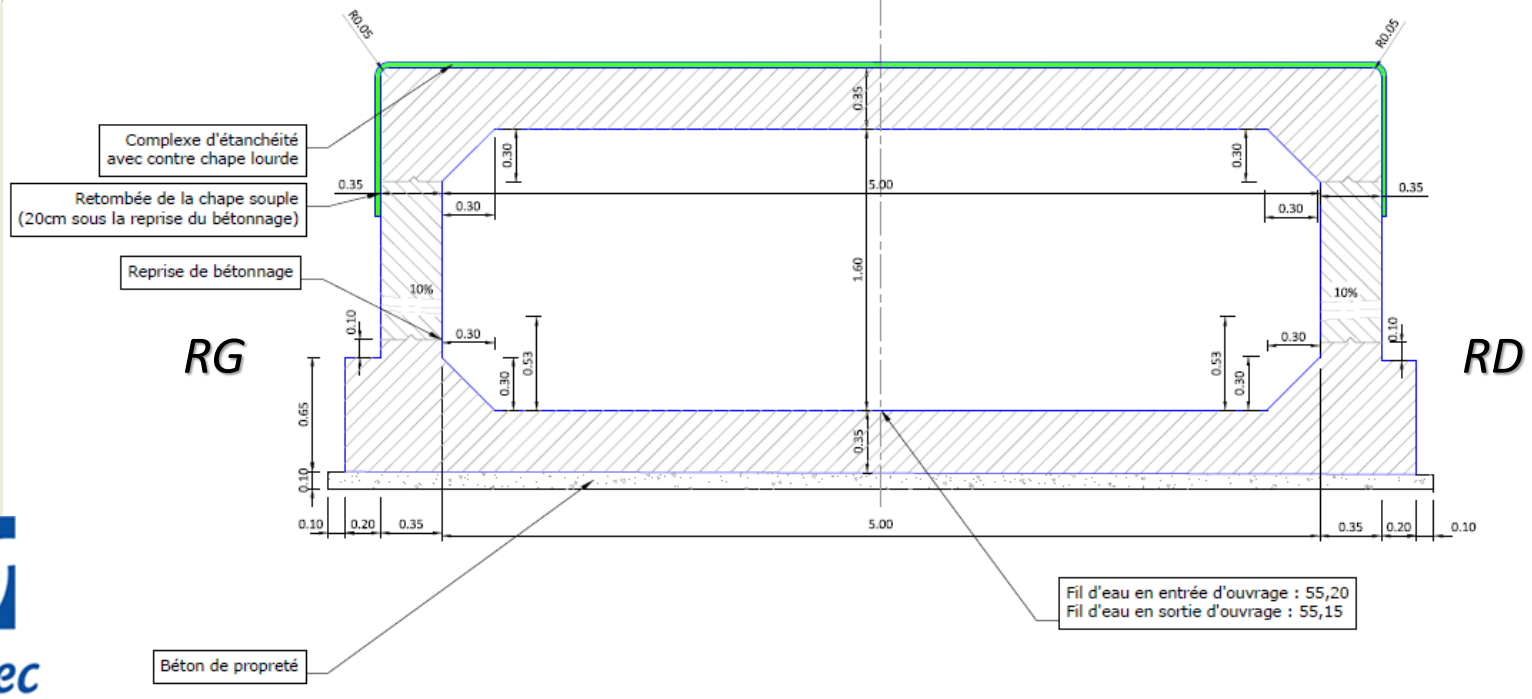
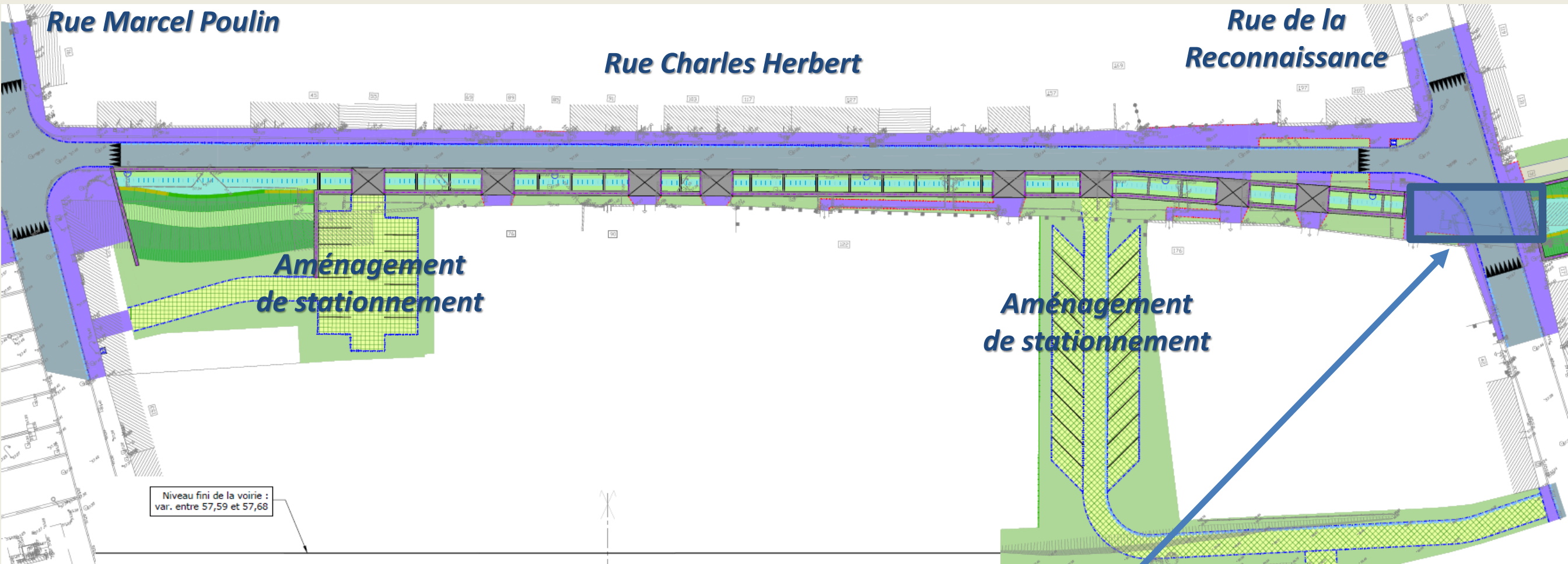

Ouvrage hydraulique au niveau de la Rue de la Reconnaissance



Aménagements prévus - Séquence 3

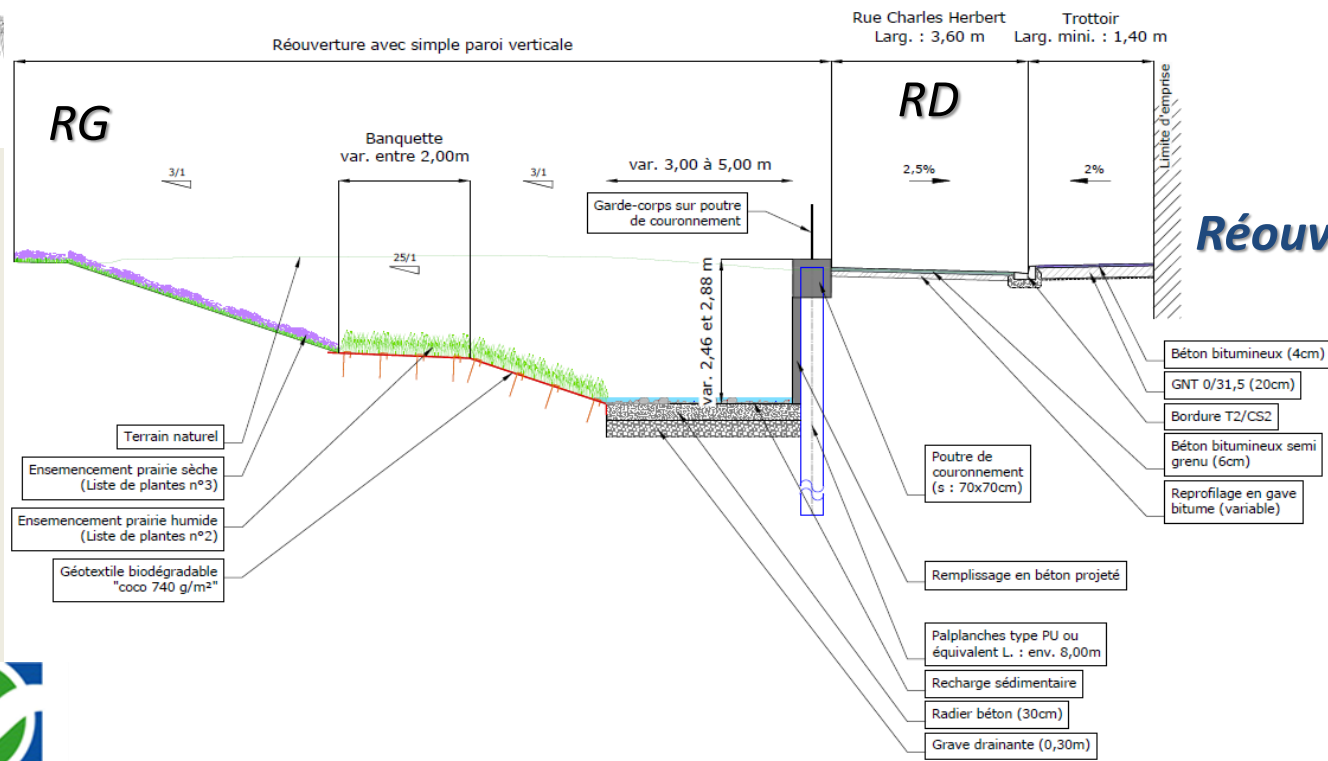
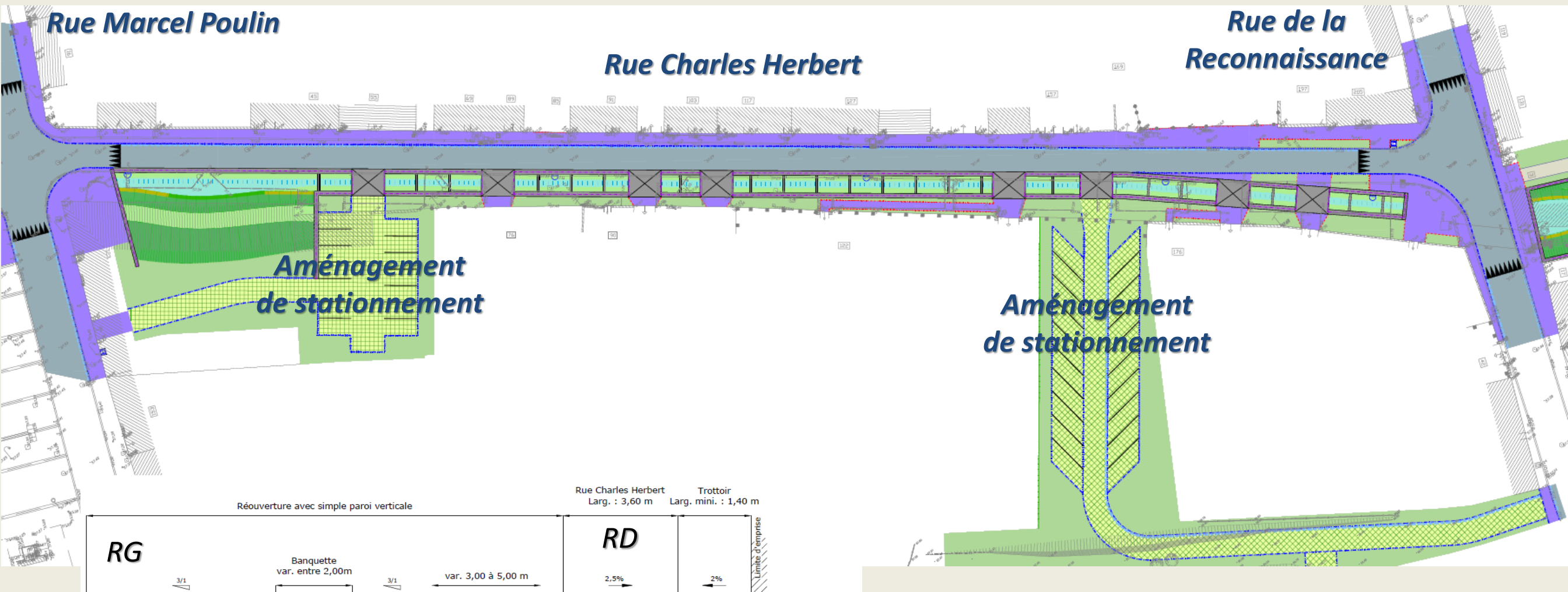

Réouverture de la verse

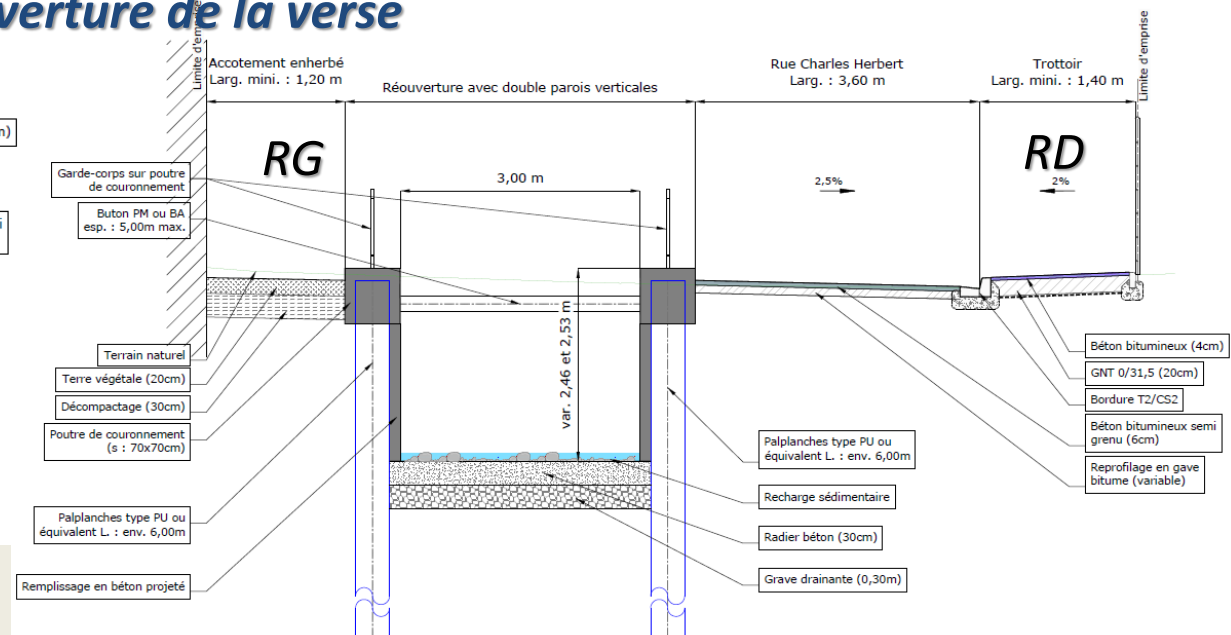



Aménagements prévus - Séquence 3

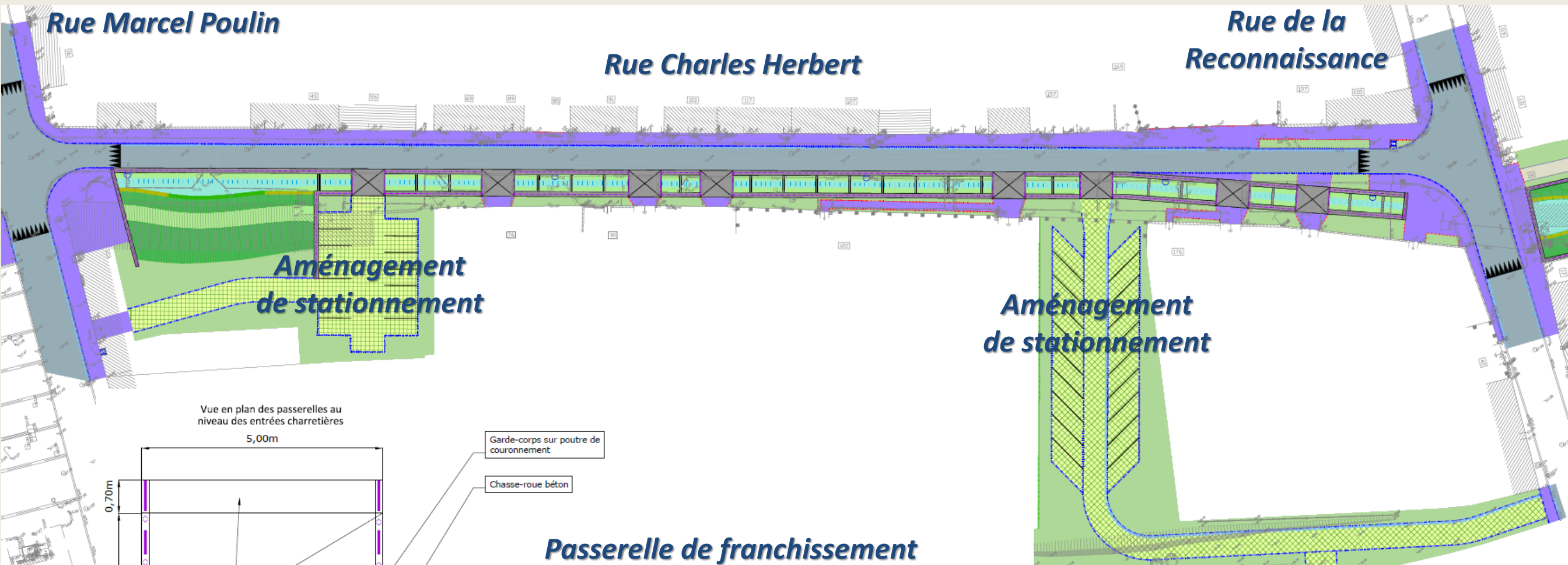

Vue en plan des passerelles au niveau des entrées charretières

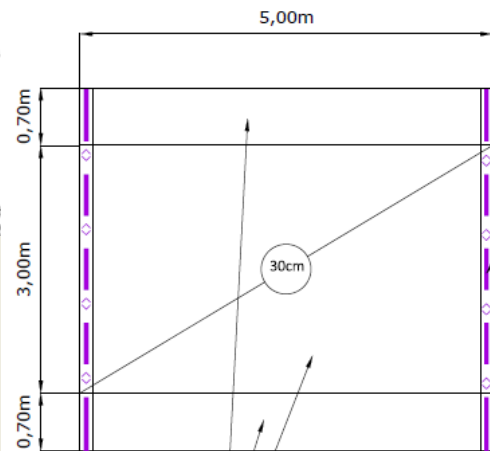

- Garde-corps sur poutre de couronnement
- Chasse-roue béton

Vue en plan des passerelles au niveau des passages piétons

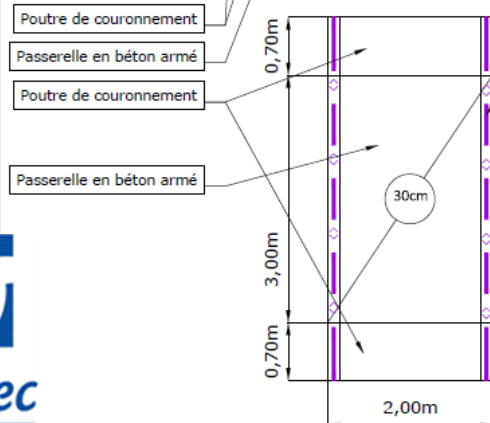

- Poutre de couronnement
- Passerelle en béton armé
- Poutre de couronnement
- Passerelle en béton armé

- Garde-corps sur poutre de couronnement
- Chasse-roue béton

Passerelle de franchissement

Coupe transversale des passerelles

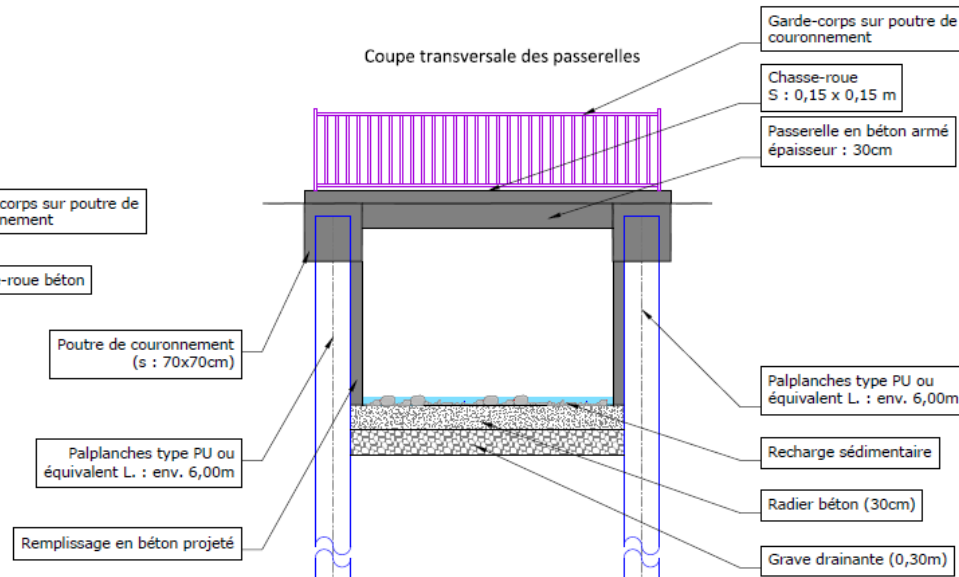

- Garde-corps sur poutre de couronnement
- Chasse-roue S : 0,15 x 0,15 m
- Passerelle en béton armé épaisseur : 30cm
- Palplanches type PU ou équivalent L : env. 6,00m
- Recharge sédimentaire
- Radier béton (30cm)
- Grave drainante (0,30m)



Aménagements prévus - Séquence 4

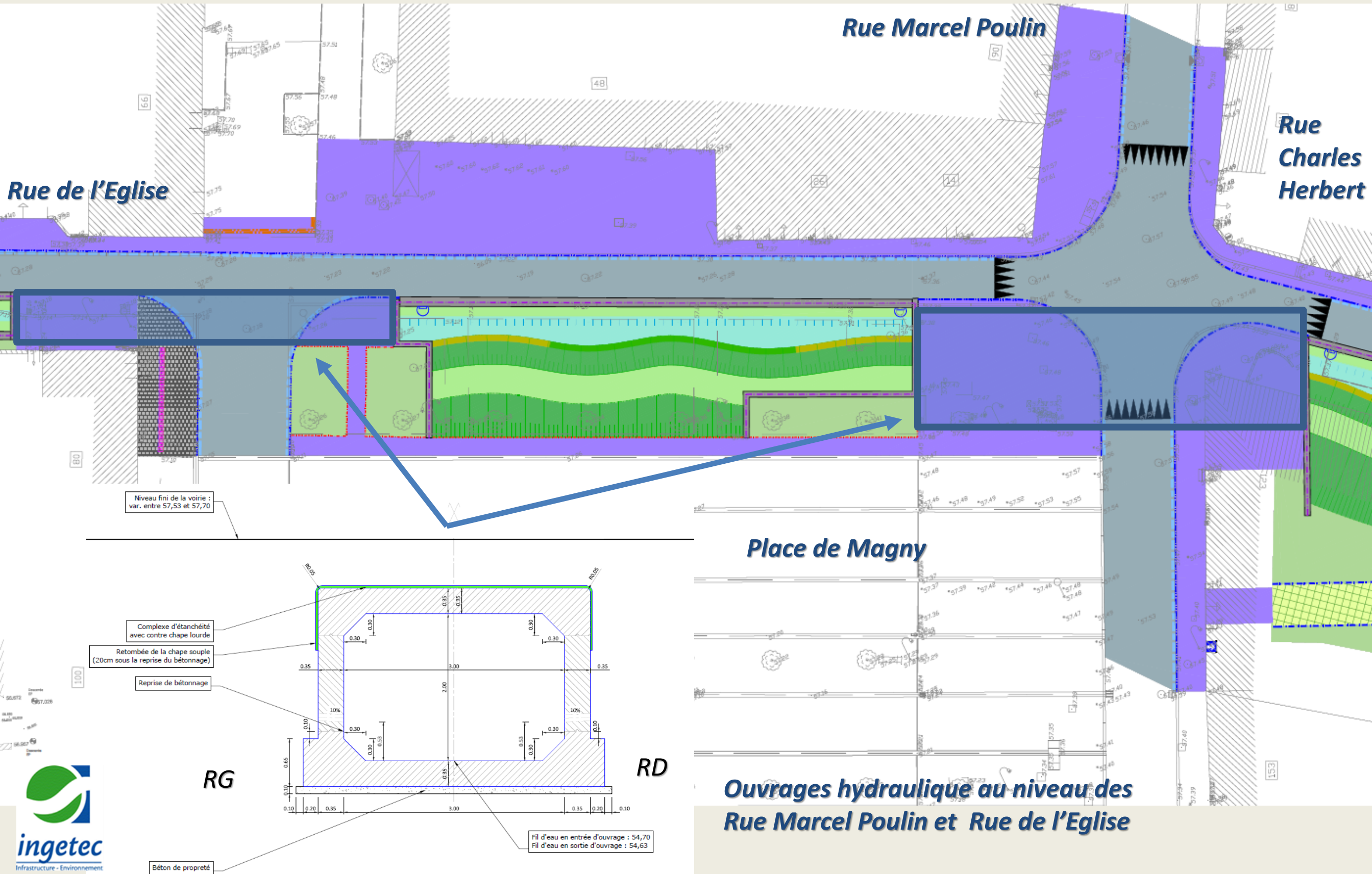



Aménagements prévus - Séquence 4

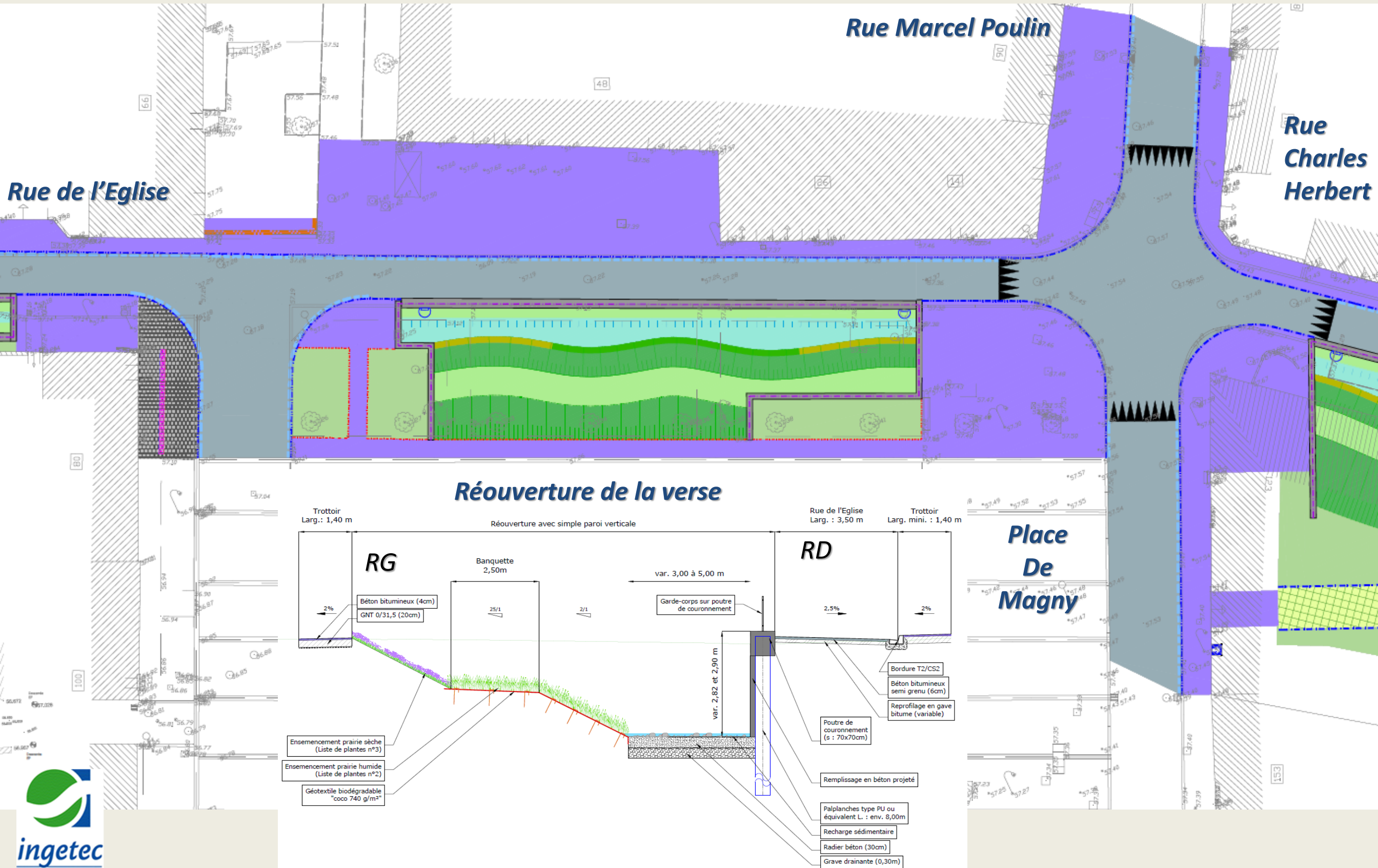



Aménagements prévus - Séquence 5

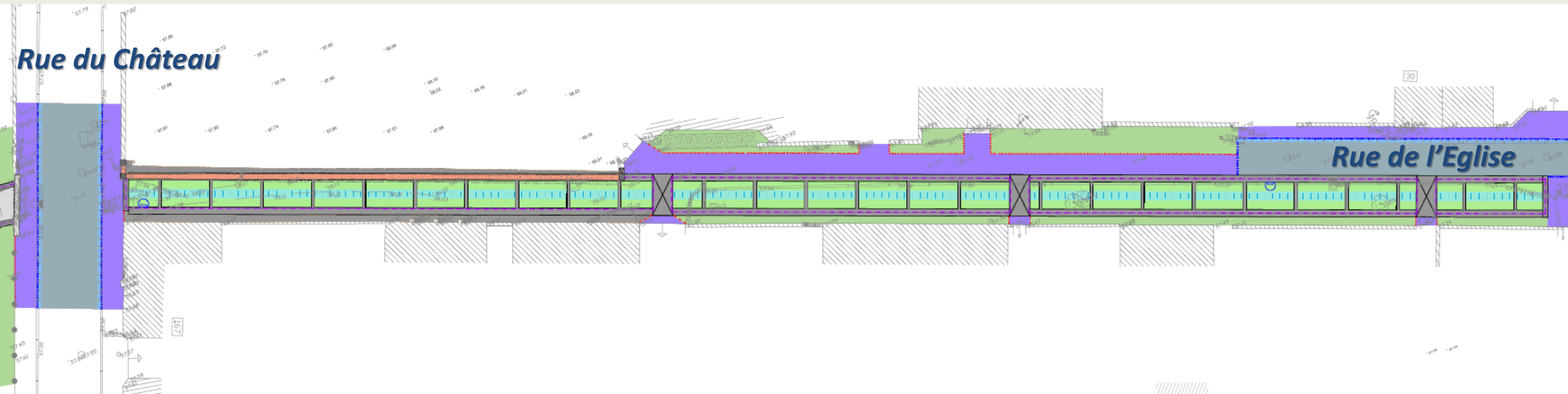

Réouverture de la verse

Au niveau du cimetière

Au niveau de la Rue de L'Eglise

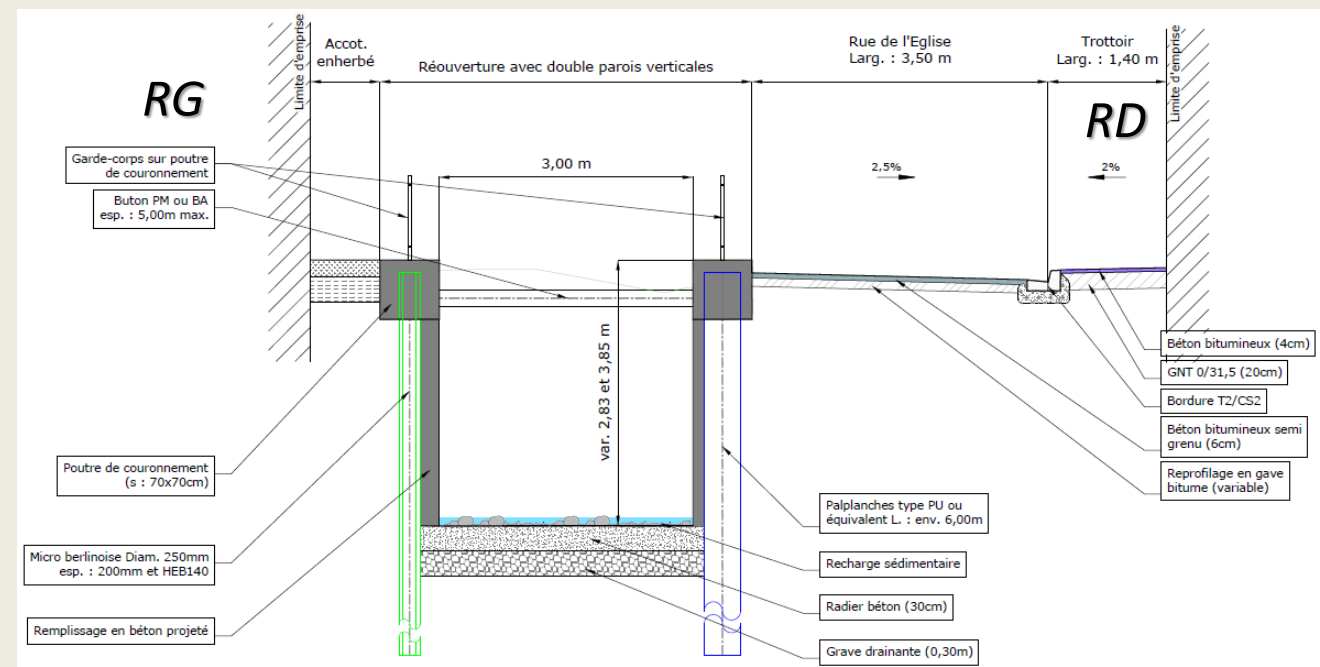
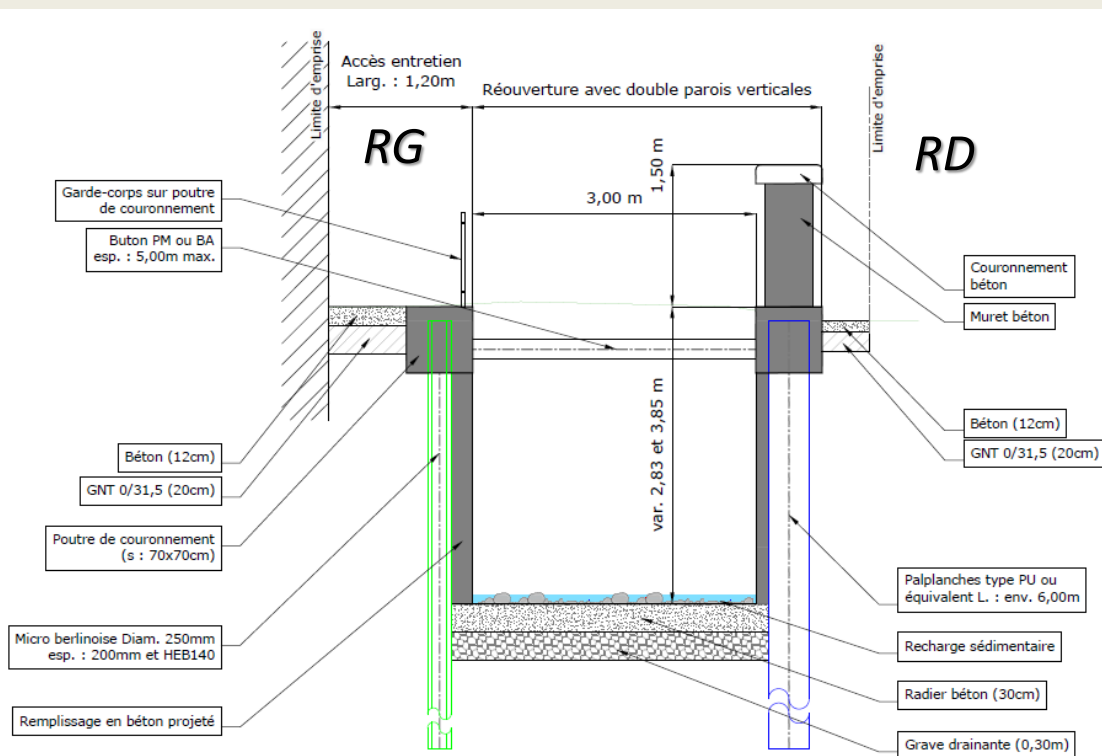



Aménagements prévus - Séquence 5

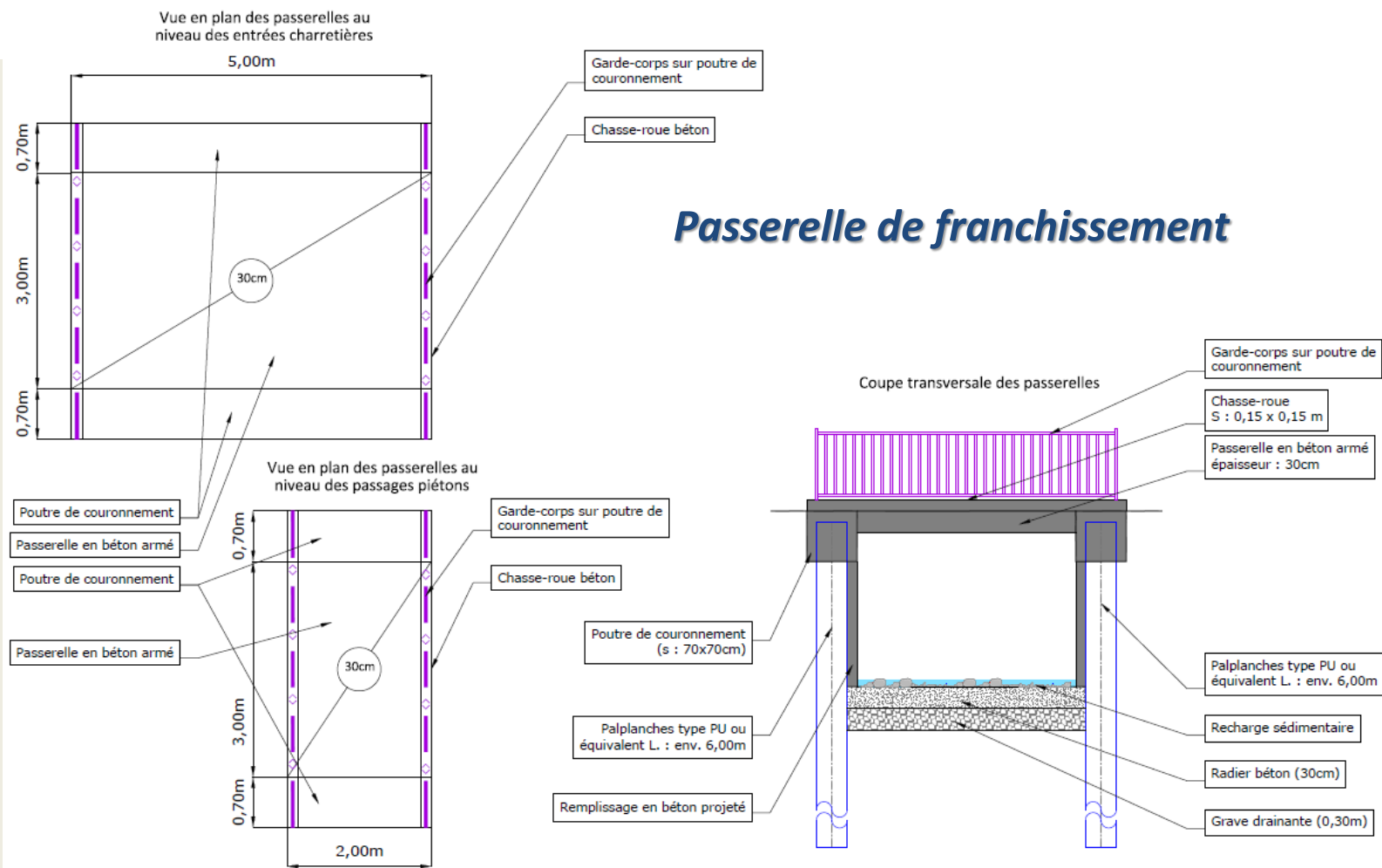
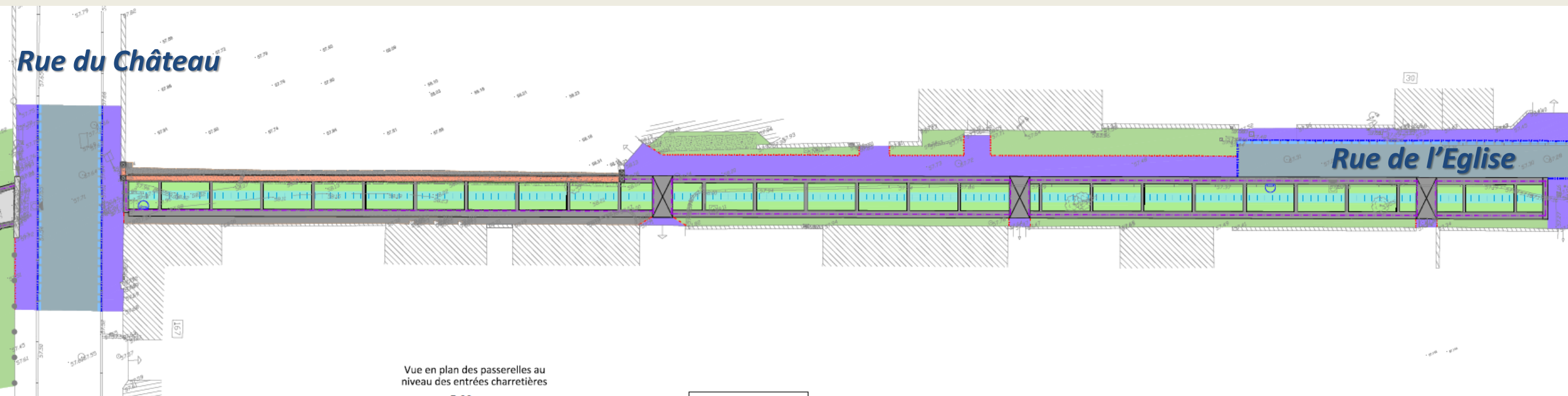



Aménagements prévus - Séquence 6

Rue
Du
Château

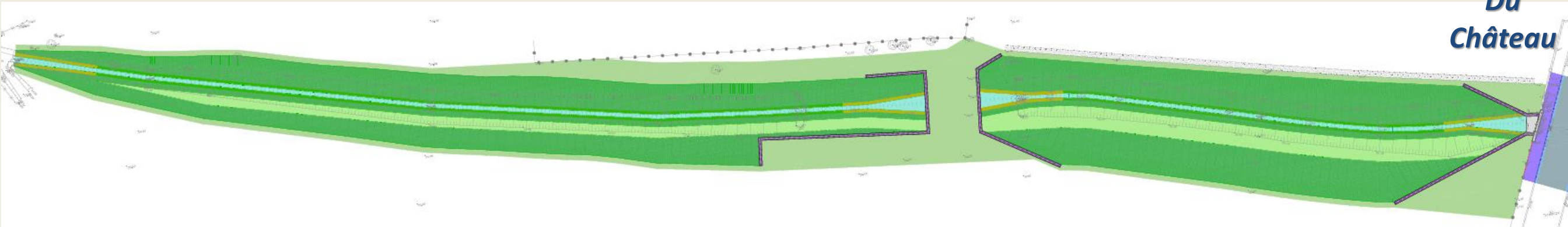

Reprofilage des berges

Avec fascines de branches de saules

Avec fascines d'hélophytes

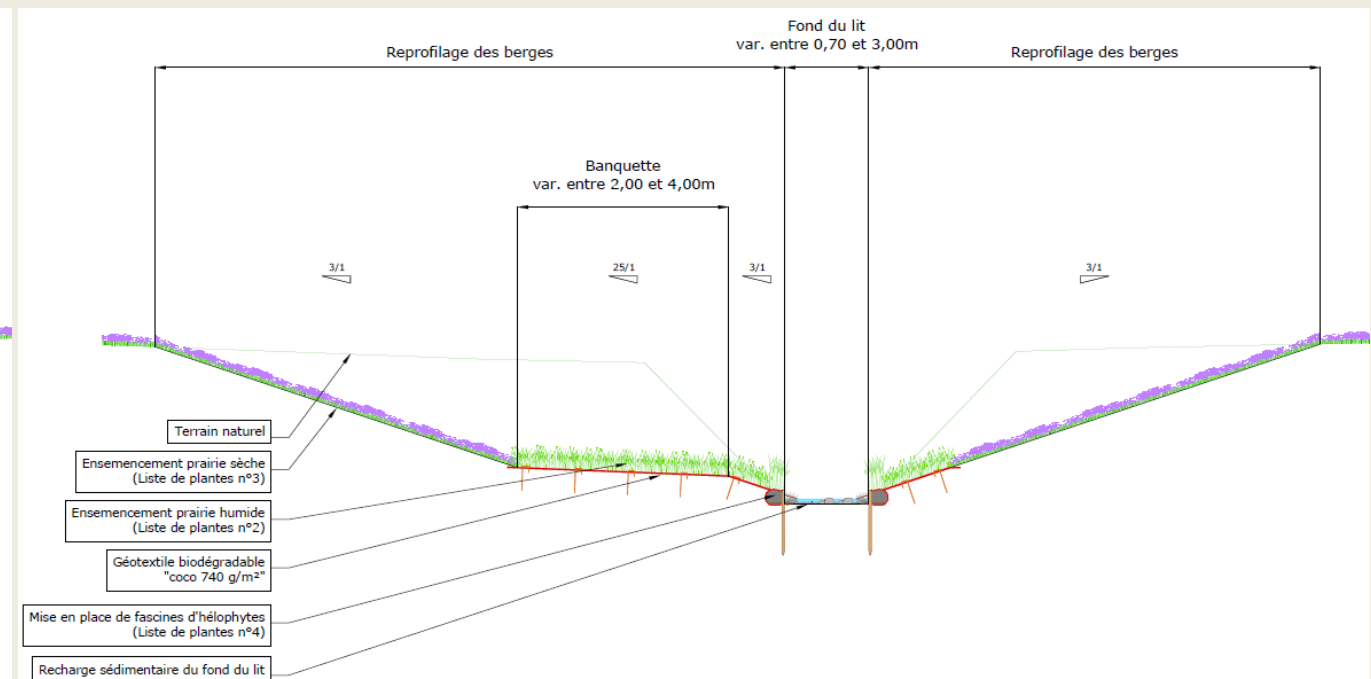
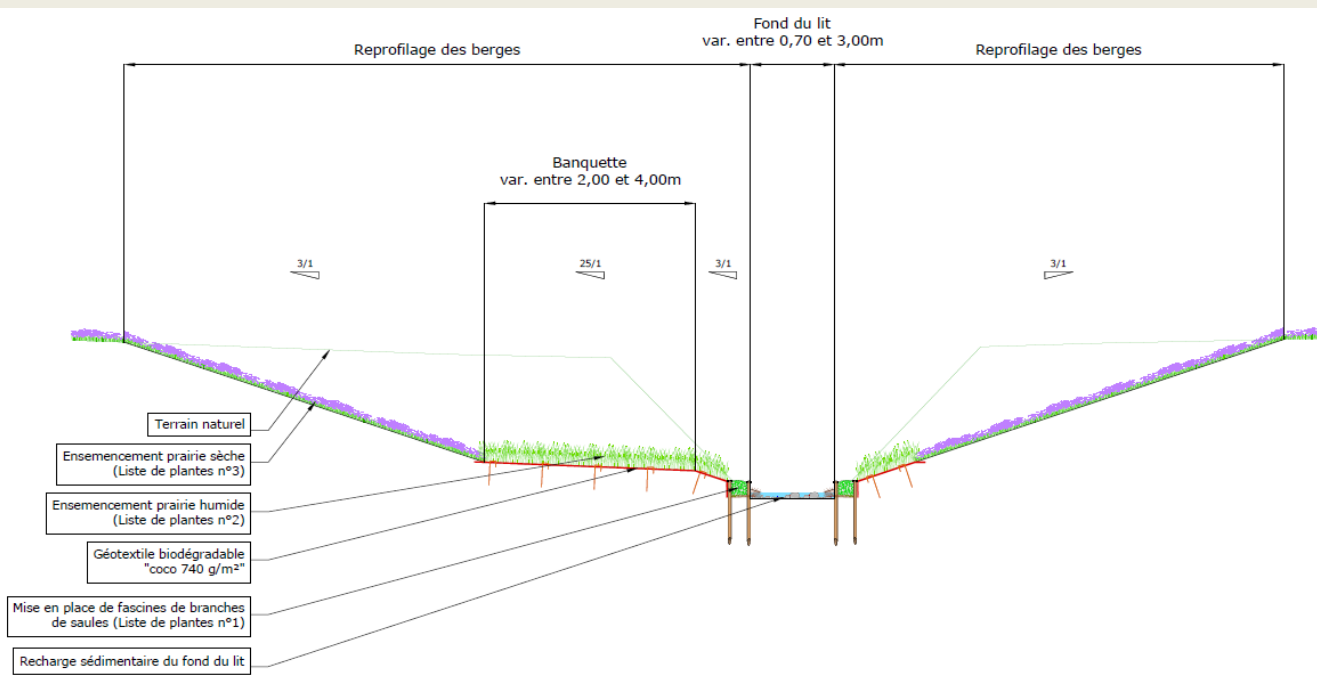



Aménagements prévus - Séquence 6

Rue Du Château

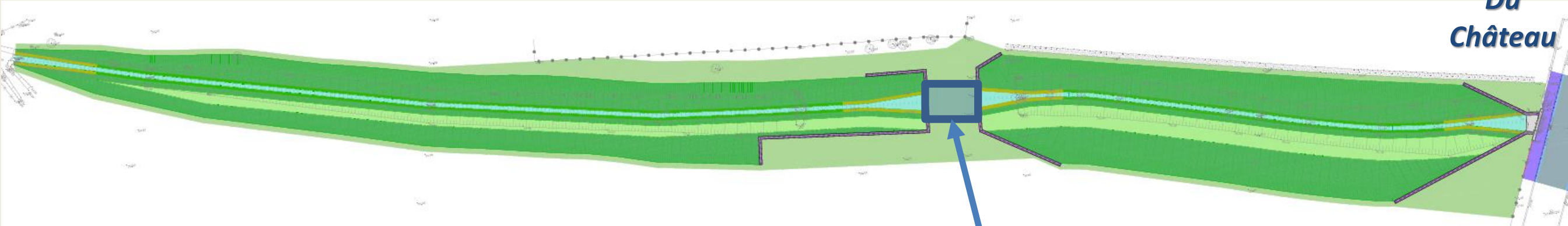

Niveau fini de la voirie :
var. entre 56,40 et 56,50

Ouvrages hydraulique

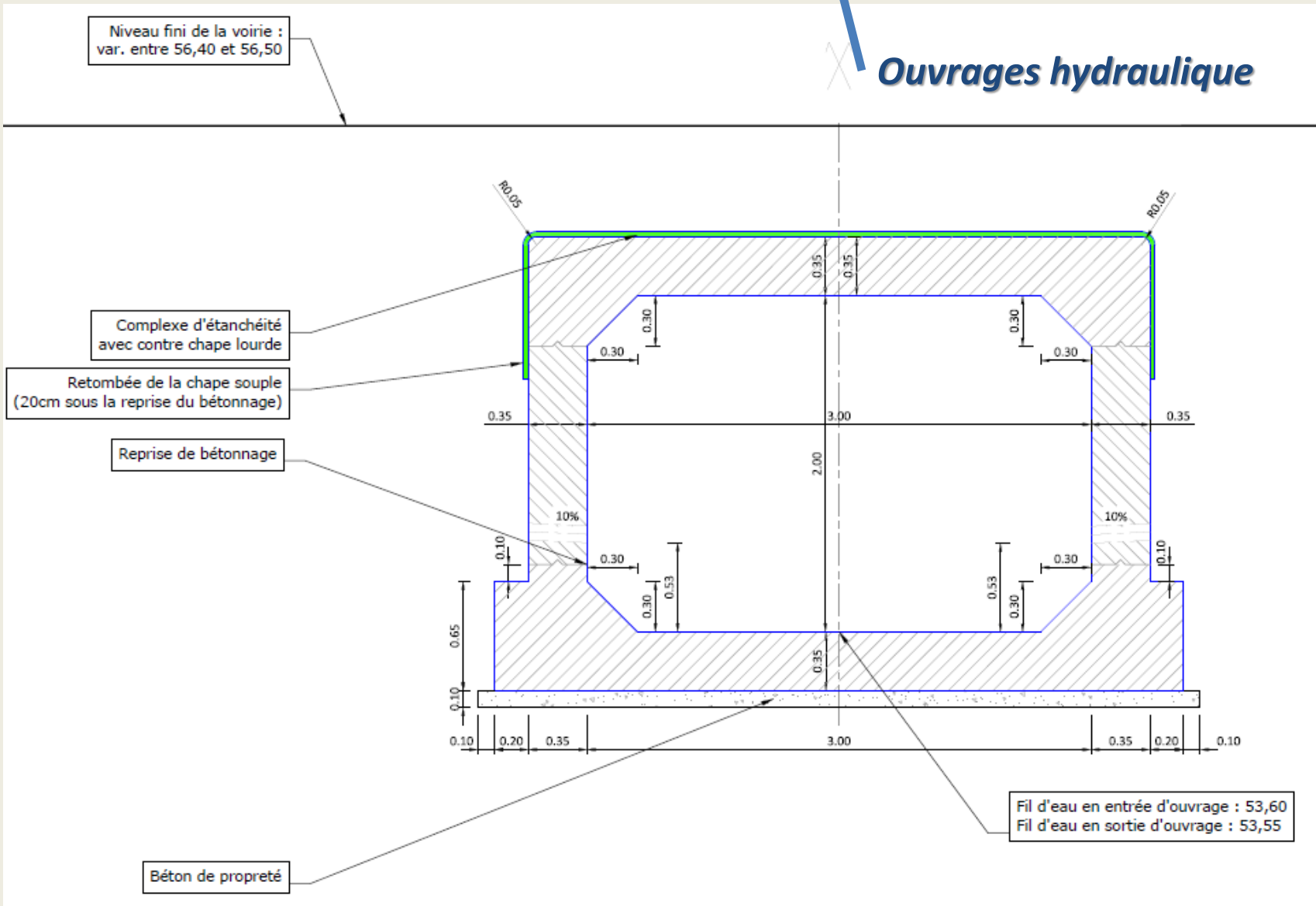



4 – Montant estimatif des travaux



Montant estimatif

Pour les travaux de restauration et de reprofilage de la Verse de Beaugies :

- *Séquences 1, 2 et 6 :* ***1 200 000,00 € HT***

Pour les travaux de réouverture de la Verse de Beaugies :

- *Séquences 3, 4 et 5 :* ***5 800 000,00 € HT***

Participation de l'Agende l'Eau :

- ***5 600 000,00 € HT (80%)***



5 – Planning prévisionnel



Planning prévisionnel

Attribution du marché public de travaux à l'entreprise :

- 1^{er} trimestre 2018

Travaux de réhabilitation du réseau d'assainissement collectif des eaux usées :

- 1^{er} semestre 2018 – Objectif : fin des travaux avant été 2018

Préparation des travaux de réouverture et de restauration :

- 2^{ème} trimestre 2018

Démarrage des travaux de réouverture et de restauration :

- Eté 2018 – Durée prévisionnelle : 18 à 24 mois